

Electromotive Force: A Guide for the Perplexed

C.J. Papachristou^a, A.N. Magoulas^b

^a *Hellenic Naval Academy, Section of Natural Sciences, Piraeus 18539, Greece*
E-mail: papachristou@snd.edu.gr

^b *Hellenic Naval Academy, Section of Electrotechnics and Computer Science,*
Piraeus 18539, Greece
E-mail: aris@snd.edu.gr

Abstract. The concept of electromotive force (emf) may be introduced in various ways in an undergraduate course of theoretical electromagnetism. The multitude of alternate expressions for the emf is often the source of confusion to the student. We summarize the main ideas, adopting a pedagogical logic that proceeds from the general to the specific. The emf of a “circuit” is first defined in the most general terms. The expressions for the emf of some familiar electrodynamic systems are then derived in a rather straightforward manner. A diversity of physical situations is thus unified within a common theoretical framework.

1. INTRODUCTION

The difficulty in writing this article was not just due to the subject itself: we had to first overcome some almost irreconcilable differences in educational philosophy between an (opinionated) theoretical physicist and an (equally -if not more- opinionated) electrical engineer. At long last, a compromise was reached! This paper is the fruit of this “mutual understanding”.

Having taught intermediate-level electrodynamics courses for several years, we have come to realize that, in the minds of many of our students, the concept of *electromotive force (emf)* is something of a mystery. What is an emf, after all? Is it the voltage of an ideal battery in a DC circuit? Is it work per unit charge? Or is it, in a more sophisticated way, the line integral of the electric field along a closed path? And what if a magnetic rather than an electric field is present?

Generally speaking, the problem with the emf lies in the diversity of situations where this concept applies, leading to a multitude of corresponding expressions for the emf. The subject is discussed in detail, of course, in all standard textbooks on electromagnetism, both at the intermediate [1-9] and at the advanced [10-12] level. Here we summarize the main ideas, choosing a pedagogical approach that proceeds from the general to the specific. We begin by defining the concept of emf of a “circuit” in the most general way possible. We then apply this definition to certain electrodynamic systems in order to recover familiar expressions for the emf. The main advantage of this approach is that a number of different physical situations are treated in a unified way within a common theoretical framework.

The general definition of the emf is given in Section 2. In subsequent sections (Sec.3-5) application is made to particular cases, such as motional emf, the emf due to a time-varying magnetic field, and the emf of a DC circuit consisting of an ideal battery and a resistor. In Sec.6, the connection between the emf and Ohm’s law is discussed.

2. THE GENERAL DEFINITION OF EMF

Consider a region of space in which an electromagnetic (e/m) field exists. In the most general sense, any *closed* path C (or *loop*) within this region will be called a “*circuit*” (whether or not the whole or parts of C consist of material objects such as wires, resistors, capacitors, batteries, or any other elements whose presence may contribute to the e/m field).

We *arbitrarily* assign a positive direction of traversing the loop C , and we consider an element \vec{dl} of C oriented in the positive direction. Imagine now a test charge q located at the position of \vec{dl} , and let \vec{F} be the force on q at time t :

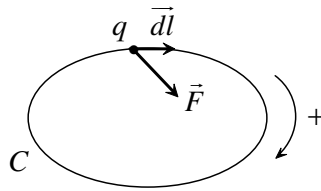

This force is exerted by the e/m field itself, as well as, possibly, by additional energy *sources* (e.g., batteries) that can interact electrically with q . The *force per unit charge* at the position of \vec{dl} at time t , is

$$\vec{f} = \frac{\vec{F}}{q} \quad (1)$$

Note that \vec{f} is independent of q , since the force by the e/m field and/or the sources on q is proportional to the charge. In particular, reversing the sign of q will have no effect on \vec{f} (although it will change the direction of \vec{F}).

We now define the *electromotive force (emf)* of the circuit C at time t as the line integral of \vec{f} along C , taken in the *positive* sense of C :

$$\mathcal{E} = \oint_C \vec{f} \cdot \vec{dl} \quad (2)$$

Note that the sign of the emf is dependent upon our choice of the positive direction of circulation of C : by changing this convention, the sign of \mathcal{E} is reversed.

We remark that, in the *non-relativistic* limit, the emf of a circuit C is the same for all inertial observers since *at this limit* the force \vec{F} is invariant under a change of frame of reference.

In the following sections we apply the defining equation (2) to a number of specific electrodynamic situations that are certainly familiar to the student.

3. MOTIONAL EMF IN THE PRESENCE OF A STATIC MAGNETIC FIELD

Consider a circuit consisting of a closed wire C . The wire is moving inside a *static* magnetic field $\vec{B}(\vec{r})$. Let \vec{v} be the velocity of the element $d\vec{l}$ of C relative to our inertial frame of reference. A charge q (say, a free electron) at the location of $d\vec{l}$ executes a composite motion, due to the motion of the loop C itself relative to our frame, as well as the motion of q *along* C . The total velocity of q relative to us is $\vec{v}_{tot} = \vec{v} + \vec{v}'$, where \vec{v}' is the velocity of q in a direction parallel to $d\vec{l}$. The force from the magnetic field on q is

$$\begin{aligned}\vec{F} &= q(\vec{v}_{tot} \times \vec{B}) = q(\vec{v} \times \vec{B}) + q(\vec{v}' \times \vec{B}) \Rightarrow \\ \vec{f} &= \frac{\vec{F}}{q} = (\vec{v} \times \vec{B}) + (\vec{v}' \times \vec{B})\end{aligned}$$

By (2), then, the emf of the circuit C is

$$\mathcal{E} = \oint_C \vec{f} \cdot d\vec{l} = \oint_C (\vec{v} \times \vec{B}) \cdot d\vec{l} + \oint_C (\vec{v}' \times \vec{B}) \cdot d\vec{l}$$

But, since \vec{v}' is parallel to $d\vec{l}$, we have that $(\vec{v}' \times \vec{B}) \cdot d\vec{l} = 0$. Thus, finally,

$$\mathcal{E} = \oint_C (\vec{v} \times \vec{B}) \cdot d\vec{l} \quad (3)$$

Note that the wire *need not maintain a fixed shape, size or orientation* during its motion! Note also that the velocity \vec{v} may vary around the circuit.

By using (3), it can be proven (see Appendix) that

$$\mathcal{E} = - \frac{d\Phi}{dt} \quad (4)$$

where $\Phi = \int \vec{B} \cdot d\vec{a}$ is the magnetic flux through the wire C at time t . Note carefully that (4) does not express any novel physical law: it is simply a direct consequence of the definition of the emf!

4. EMF DUE TO A TIME-VARYING MAGNETIC FIELD

Consider now a closed wire C that is *at rest* inside a *time-varying* magnetic field $\vec{B}(\vec{r}, t)$. As experiments show, as soon as \vec{B} starts changing, a current begins to flow in the wire. This looks impressive, given that the free charges in the (stationary) wire were initially at rest. And, as everybody knows, a magnetic field exerts forces on *moving* charges only! It is also observed experimentally that, if the magnetic field \vec{B} stops varying in time, the current in the wire

disappears. The only field that can put an initially stationary charge in motion and keep this charge moving is an *electric* field.

We are thus compelled to conclude that *a time-varying magnetic field is necessarily accompanied by an electric field*. (It is often said that “a changing magnetic field *induces* an electric field”. This is somewhat misleading since it gives the impression that the “source” of an electric field could be a magnetic field. Let us keep in mind, however, that the true sources of any e/m field are the electric charges and the electric currents!)

So, let $\vec{E}(\vec{r}, t)$ be the electric field accompanying the time-varying magnetic field \vec{B} . Consider again a charge q at the position of the element \vec{dl} of the wire. Given that the wire is now at rest (relative to our inertial frame), the velocity of q will be due to the motion of the charge along the wire only, i.e., in a direction parallel to \vec{dl} : $\vec{v}_{tot} = \vec{v}'$ (since $\vec{v} = 0$). The force on q by the e/m field is

$$\vec{F} = q [\vec{E} + (\vec{v}_{tot} \times \vec{B})] = q [\vec{E} + (\vec{v}' \times \vec{B})] \Rightarrow$$

$$\vec{f} = \frac{\vec{F}}{q} = \vec{E} + (\vec{v}' \times \vec{B})$$

The emf of the circuit C is now

$$\mathcal{E} = \oint_C \vec{f} \cdot \vec{dl} = \oint_C \vec{E} \cdot \vec{dl} + \oint_C (\vec{v}' \times \vec{B}) \cdot \vec{dl}$$

But, as explained earlier, $(\vec{v}' \times \vec{B}) \cdot \vec{dl} = 0$. Thus, finally,

$$\mathcal{E} = \oint_C \vec{E} \cdot \vec{dl} \tag{5}$$

Equation (4) is still valid. This time, however, it is not merely a mathematical consequence of the definition of the emf ; rather, it is a true physical law deduced from experiment! Let us examine it in some detail.

In a region of space where a time-varying e/m field (\vec{E}, \vec{B}) exists, consider an arbitrary open surface S bounded by the closed curve C :

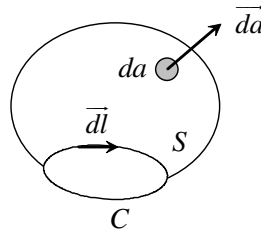

(The *relative* direction of \vec{dl} and the surface element \vec{da} , normal to S , is determined according to the familiar right-hand rule.) The loop C is assumed stationary relative to the inertial observer; hence the emf along C at time t is given by (5). The magnetic flux through S at this instant is

$$\Phi_m(t) = \int_S \vec{B} \cdot \vec{da}$$

(Note that the signs of \mathcal{E} and Φ_m depend on the chosen positive direction of C .) Since the field \vec{B} is *solenoidal*, the value of Φ_m for a given C is independent of the choice of the surface S . That is, the same magnetic flux will go through *any* open surface bounded by the closed curve C .

According to the *Faraday-Henry law*,

$$\mathcal{E} = - \frac{d\Phi_m}{dt} \quad (6)$$

or explicitly,

$$\oint_C \vec{E} \cdot \vec{dl} = - \frac{d}{dt} \int_S \vec{B} \cdot \vec{da} \quad (7)$$

(The negative sign on the right-hand sides of (6) and (7) expresses *Lenz's law*.)

Equation (7) can be re-expressed in differential form by using Stokes' theorem,

$$\oint_C \vec{E} \cdot \vec{dl} = \int_S (\vec{\nabla} \times \vec{E}) \cdot \vec{da}$$

and by taking into account that the surface S may be arbitrarily chosen. The result is

$$\vec{\nabla} \times \vec{E} = - \frac{\partial \vec{B}}{\partial t} \quad (8)$$

We note that if $\partial \vec{B} / \partial t \neq 0$, then necessarily $\vec{E} \neq 0$. Hence, as already mentioned, a time-varying magnetic field is always accompanied by an electric field. If, however, \vec{B} is *static* ($\partial \vec{B} / \partial t = 0$), then \vec{E} is *irrotational*: $\vec{\nabla} \times \vec{E} = 0 \Leftrightarrow \oint_C \vec{E} \cdot \vec{dl} = 0$, which allows for the possibility that $\vec{E} = 0$.

Corollary: The emf around a *fixed* loop C inside a *static* e/m field ($\vec{E}(\vec{r}), \vec{B}(\vec{r})$) is $\mathcal{E} = 0$ (the student should explain this).

5. EMF OF A CIRCUIT CONTAINING A BATTERY AND A RESISTOR

Consider a circuit consisting of an ideal battery (i.e., one with no internal resistance) connected to an external resistor. As shown below, the emf of the circuit *in the direction of the current* is equal to the voltage V of the battery. Moreover, the emf in this case represents the *work per unit charge* done by the source (battery).

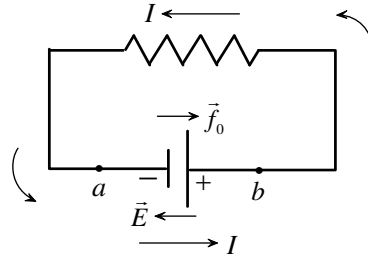

We recall that, in general, the emf of a circuit C at time t is equal to the integral

$$\mathcal{E} = \oint_C \vec{f} \cdot d\vec{l}$$

where $\vec{f} = \vec{F}/q$ is the force per unit charge at the location of the element $d\vec{l}$ of the circuit, at time t . In essence, we assume that in every element $d\vec{l}$ we have placed a test charge q (this could be, e.g., a free electron of the conducting part of the circuit). The force \vec{F} on each q is then measured *simultaneously* for all charges at time t . Since here we are dealing with a *static* (time-independent) situation, however, we can treat the problem somewhat differently: The measurements of the forces \vec{F} on the charges q need not be made at the same instant, given that nothing changes with time, anyway. So, instead of placing several charges q around the circuit and measuring the forces \vec{F} on each of them at a particular instant, we imagine *a single charge* q making a complete tour around the loop C . We may assume, e.g., that the charge q is one of the (*conventionally positive*) free electrons taking part in the constant current I flowing in the circuit. We then measure the force \vec{F} on q at each point of C .

We thus assume that q is a *positive* charge moving *in the direction of the current* I . We also assume that the direction of circulation of C is the *same as the direction of the current* (counterclockwise in the figure). During its motion, q is subject to two forces: (1) the force \vec{F}_0 by the source (battery) that carries q from the negative pole a to the positive pole b *through the source*, and (2) the electrostatic force $\vec{F}_e = q\vec{E}$ due to the electrostatic field \vec{E} at each point of the circuit C (both inside and outside the source). The total force on q is

$$\vec{F} = \vec{F}_0 + \vec{F}_e = \vec{F}_0 + q\vec{E} \Rightarrow \vec{f} = \frac{\vec{F}}{q} = \frac{\vec{F}_0}{q} + \vec{E} \equiv \vec{f}_0 + \vec{E}$$

Then,

$$\mathcal{E} = \oint_C \vec{f} \cdot d\vec{l} = \oint_C \vec{f}_0 \cdot d\vec{l} + \oint_C \vec{E} \cdot d\vec{l} = \oint_C \vec{f}_0 \cdot d\vec{l} \quad (9)$$

since $\oint_C \vec{E} \cdot d\vec{l} = 0$ for an electrostatic field. However, the action of the source on q is limited to the region between the poles of the battery, that is, the section of the circuit from a to b . Hence, $\vec{f}_0 = 0$ *outside* the source, so that (9) reduces to

$$\mathcal{E} = \int_a^b \vec{f}_0 \cdot d\vec{l} \quad (10)$$

Now, since the current I is constant, the charge q moves at constant speed along the circuit. This means that the *total* force on q in the direction of the path C is zero. In the interior of the resistor, the electrostatic force $\vec{F}_e = q\vec{E}$ is counterbalanced by the force on q due to the collisions of the charge with the positive ions of the metal (this latter force does *not* contribute to the emf and is *not* counted in its evaluation!). In the interior of the (ideal) battery, however, where there is no resistance, the electrostatic force \vec{F}_e must be counterbalanced by the *opposing* force \vec{F}_0 exerted by the source. Thus, in the section of the circuit between a and b ,

$$\vec{F} = \vec{F}_0 + \vec{F}_e = 0 \Rightarrow \vec{f} = \frac{\vec{F}}{q} = \vec{f}_0 + \vec{E} = 0 \Rightarrow \vec{f}_0 = -\vec{E}$$

Equation (10) then takes the final form,

$$\mathcal{E} = -\int_a^b \vec{E} \cdot \vec{dl} = V_b - V_a = V \quad (11)$$

where V_a and V_b are the electrostatic potentials at a and b , respectively. This is, of course, what every student knows from elementary e/m courses!

The work done by the source on q upon transferring the charge from a to b is

$$W = \int_a^b \vec{F}_0 \cdot \vec{dl} = q \int_a^b \vec{f}_0 \cdot \vec{dl} = q\mathcal{E} \quad (12)$$

[where we have used (10)]. So, the *work of the source per unit charge* is $W/q = \mathcal{E}$. This work is converted into heat in the resistor, so that the source must again supply energy in order to carry the charges once more from a to b . This is something like the torture of Sisyphus in Greek mythology!

6. EMF AND OHM'S LAW

Consider a closed wire C inside an e/m field. The circuit may contain sources (e.g., a battery) and may also be in motion relative to our inertial frame of reference. Let q be a test charge at the location of the element \vec{dl} of C , and let \vec{F} be the total force on q (due to the e/m field and/or the sources) at time t . (As mentioned in Sec.2, this force is, classically, a frame-independent quantity.) The force per unit charge at the location of \vec{dl} at time t , then, is $\vec{f} = \vec{F}/q$. According to our general definition, the emf of the circuit at time t is

$$\mathcal{E} = \oint_C \vec{f} \cdot \vec{dl} \quad (13)$$

Now, if σ is the *conductivity* of the wire, then, by *Ohm's law* in its general form (see, e.g., p. 285 of [1]) we have:

$$\vec{J} = \sigma \vec{f} \quad (14)$$

where \vec{J} is the *volume current density* at the location of \vec{dl} at time t . (Note that the more common expression $\vec{J} = \sigma \vec{E}$, found in most textbooks, is a special case of the above formula. Note also that \vec{J} is measured *relative to the wire*, thus is the same for all inertial observers.) By combining (13) and (14) we get:

$$\mathcal{E} = \frac{1}{\sigma} \oint_C \vec{J} \cdot \vec{dl} \quad (15)$$

Taking into account that \vec{J} is in the direction of \vec{dl} at each point of C , we write:

$$\vec{J} \cdot \vec{dl} = J dl = \frac{I}{S} dl$$

where S is the *constant* cross-sectional area of the wire. If we make the additional assumption that, at each instant t , the current I is constant around the circuit (although I may vary with time), we finally get:

$$\mathcal{E} = \frac{l}{\sigma S} I = \frac{\rho l}{S} I = IR \quad (16)$$

where l is the total length of the wire, $\rho = 1/\sigma$ is the *resistivity* of the material, and R is the total resistance of the circuit. Equation (16) is the familiar special form of Ohm's law.

As an example, let us return to the circuit of Sec.5, this time assuming a *non-ideal* battery with internal resistance r . Let R_0 be the external resistance connected to the battery. The total resistance of the circuit is $R = R_0 + r$. As before, we call $V = V_b - V_a$ the potential difference between the terminals of the battery, which is equal to the voltage across the external resistor. Hence, $V = IR_0$, where I is the current in the circuit. The emf of the circuit (in the direction of the current) is

$$\mathcal{E} = IR = I(R_0 + r) = V + Ir$$

Note that the potential difference V between the terminals a and b equals the emf only when no current is flowing ($I=0$).

As another example, consider a circuit C containing an ideal battery of voltage V and having total resistance R and total *inductance* L :

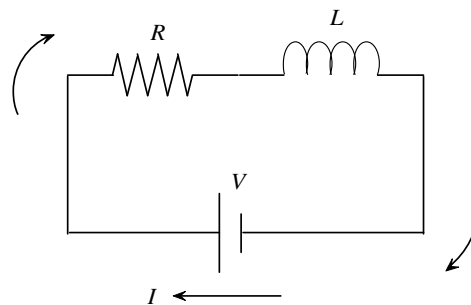

In this case, the emf of C in the direction of the current flow is

$$\mathcal{E}(t) = V + V_L = V - L \frac{dI}{dt} = I(t)R$$

To understand why the total emf of the circuit is $V + V_L$, we think as follows: On its tour around the circuit, a test charge q is subject to two forces (ignoring collisions with the positive ions in the interior of the wire): a force *inside* the source, and a force by the *non-conservative* electric field accompanying the time-varying magnetic flux through the circuit. Hence, the total emf will be the sum of the emf due to the (ideal) battery alone and the emf expressed by the Faraday-Henry law (6). The latter emf is precisely V_L ; it has a nonzero value for as long as the current I is changing.

Some interesting energy considerations are here in order. The total power supplied to the circuit by the battery at time t is

$$P = IV = I^2R + LI \frac{dI}{dt}$$

The term I^2R represents the power *irreversibly lost* as heat in the resistor (energy, per unit time, spent in moving the electrons through the crystal lattice of the conductor and transferred to the ions that make up the lattice). Thus, this power must necessarily be supplied back by the source in order to *maintain* the current against dissipative losses in the resistor. On the other hand, the term $LI (dI/dt)$ represents the energy per unit time required to *build up* the current against the “back emf” V_L . This energy is *retrievable* and is given back to the source when the current decreases. It may also be interpreted as energy per unit time required in order to *establish the magnetic field* associated with the current. This energy is “stored” in the magnetic field surrounding the circuit.

7. CONCLUDING REMARKS

In concluding this article, let us highlight a few points of importance:

1. The emf was defined as a line integral of force per unit charge around a loop (or “circuit”) in an e/m field. The loop may or may not consist of a real conducting wire, and it may contain sources such as batteries.
2. In the classical (non-relativistic) limit, the emf is independent of the inertial frame of reference with respect to which it is measured.
3. In the case of *purely motional* emf, Faraday’s “law” (4) is in essence a mere consequence of the definition of the emf. On the contrary, when a time-dependent magnetic field is present, the similar-looking equation (6) is a true physical law (the Faraday-Henry law).
4. In a DC circuit with a battery, the emf in the direction of the current equals the voltage of the battery and represents work per unit charge done by the source.
5. If the loop describing the circuit represents a conducting wire of finite resistance, Ohm’s law can be expressed in terms of the emf by equation (16).

APPENDIX

Here is an analytical proof of equation (4) of Sec.3:

Assume that, at time t , the wire describes a closed curve C that is the boundary of a plane surface S . At time $t' = t + dt$, the wire (which has moved in the meanwhile) describes another curve C' that encloses a surface S' . Let \vec{dl} be an element of C in the direction of circulation of the curve, and let \vec{v} be the velocity of this element relative to an inertial observer (the velocity of the elements of C may vary along the curve):

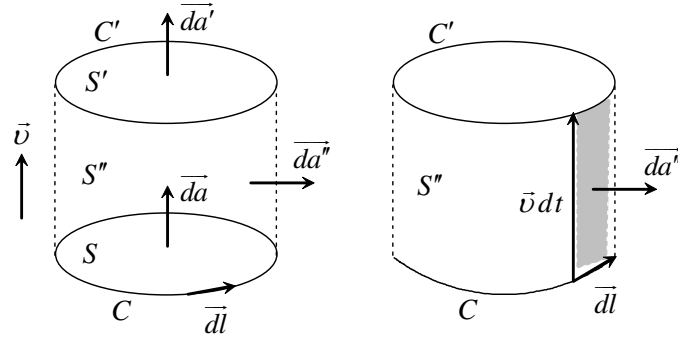

The direction of the surface elements \vec{da} and \vec{da}' is consistent with the chosen direction of \vec{dl} , according to the right-hand rule. The element of the side (“cylindrical”) surface S'' formed by the motion of C , is equal to

$$\vec{da}'' = \vec{dl} \times (\vec{v} dt) = (\vec{dl} \times \vec{v}) dt$$

Since the magnetic field is static, we can view the situation in a somewhat different way: Rather than assuming that the curve C moves within the time interval dt so that its points coincide with the points of the curve C' at time t' , we consider two *constant* curves C and C' at *the same instant* t . In the case of a *static* field \vec{B} , the magnetic flux through C' at time $t' = t + dt$ (according to our original assumption of a moving curve) is the same as the flux through this same curve at time t , given that no change of the magnetic field occurs within the time interval dt . Now, we note that the open surfaces $S_1 = S$ and $S_2 = S' \cup S''$ share a common boundary, namely, the curve C . Since the magnetic field is *solenoidal*, the same magnetic flux Φ_m passes through S_1 and S_2 at time t . That is,

$$\int_{S_1} \vec{B} \cdot \vec{da}_1 = \int_{S_2} \vec{B} \cdot \vec{da}_2 \Rightarrow \int_S \vec{B} \cdot \vec{da} = \int_{S'} \vec{B} \cdot \vec{da}' + \int_{S''} \vec{B} \cdot \vec{da}''$$

But, returning to our initial assumption of a *moving* curve, we note that

$$\int_S \vec{B} \cdot \vec{da} = \Phi_m(t) = \text{magnetic flux through the wire at time } t$$

and

$$\int_{S'} \vec{B} \cdot \overline{da'} = \Phi_m(t+dt) = \text{magnetic flux through the wire at time } t+dt$$

Hence,

$$\begin{aligned} \Phi_m(t) &= \Phi_m(t+dt) + \int_{S''} \vec{B} \cdot \overline{da''} \Rightarrow \\ d\Phi_m &= \Phi_m(t+dt) - \Phi_m(t) = - \int_{S''} \vec{B} \cdot \overline{da''} = - dt \oint_C \vec{B} \cdot (\overline{dl} \times \vec{v}) \Rightarrow \\ - \frac{d\Phi_m}{dt} &= \oint_C \vec{B} \cdot (\overline{dl} \times \vec{v}) = \oint_C (\vec{v} \times \vec{B}) \cdot \overline{dl} = \mathcal{E} \end{aligned}$$

in accordance with (3) and (4).

REFERENCES

1. D. J. Griffiths, *Introduction to Electrodynamics*, 3rd Edition (Prentice-Hall, 1999).
2. R. K. Wangsness, *Electromagnetic Fields*, 2nd Edition (Wiley, 1986).
3. J. R. Reitz, F. J. Milford, R. W. Christy, *Foundations of Electromagnetic Theory*, 4th Edition (Addison-Wesley, 1993).
4. W. N. Cottingham, D. A. Greenwood, *Electricity and Magnetism* (Cambridge, 1991).
5. P. Lorrain, D. R. Corson, F. Lorrain, *Electromagnetic Fields and Waves*, 3rd Edition (Freeman, 1988).
6. V. Rojansky, *Electromagnetic Fields and Waves* (Dover, 1979).
7. A. Shadowitz, *The Electromagnetic Field* (McGraw-Hill, 1975).
8. C. J. Papachristou, *Introduction to Electromagnetic Theory and the Physics of Conducting Solids*, 2nd Edition, in Greek (Naval Academy of Greece Publications, 2010).
9. A. N. Magoulas, *Applied Electromagnetism*, 2nd Edition, in Greek (Naval Academy of Greece Publications, 2012).
10. J. D. Jackson, *Classical Electrodynamics*, 3rd Edition (Wiley, 1999)¹.
11. W. K. H. Panofsky, M. Phillips, *Classical Electricity and Magnetism*, 2nd Edition (Addison-Wesley, 1962).
12. W. Greiner, *Classical Electrodynamics* (Springer, 1998).

¹ One of us (C.J.P.) strongly feels that the 2nd Edition of 1975 (unfortunately out of print) was a much better edition!

Does the electromotive force (always) represent work?

C. J. Papachristou^{1*} and A. N. Magoulas²

¹Department of Physical Sciences, Naval Academy of Greece, Piraeus, Greece

²Department of Electrical Engineering, Naval Academy of Greece, Piraeus, Greece

* papachristou@snd.edu.gr

Abstract

In the literature of Electromagnetism, the electromotive force of a “circuit” is often defined as work done on a unit charge during a complete tour of the latter around the circuit. We explain why this statement cannot be generally regarded as true, although it is indeed true in certain simple cases. Several examples are used to illustrate these points.

1. Introduction

In a recent paper [1] the authors suggested a pedagogical approach to the *electromotive force* (emf) of a “circuit”, a fundamental concept of Electromagnetism. Rather than defining the emf in an *ad hoc* manner for each particular electrodynamic system, this approach begins with the most general definition of the emf and then specializes to certain cases of physical interest, thus recovering the familiar expressions for the emf.

Among the various examples treated in [1], the case of a simple battery-resistor circuit was of particular interest since, in this case, the emf was shown to be equal to the *work, per unit charge*, done by the source (battery) for a complete tour around the circuit. Now, in the literature of Electrodynamics the emf is often *defined* as work per unit charge. As we explain in this paper, this is not generally true except for special cases, such as the aforementioned one.

In Section 2, we give the general definition of the emf, \mathcal{E} , and, separately, that of the work per unit charge, w , done by the agencies responsible for the generation and preservation of a current flow in the circuit. We then state the necessary conditions in order for the equality $\mathcal{E}=w$ to hold. We stress that, by their very definitions, \mathcal{E} and w are *different* concepts.

Thus, the equation $\mathcal{E}=w$ suggests the possible equality of the *values* of two physical quantities, not the conceptual identification of these quantities!

Section 3 reviews the case of a circuit consisting of a battery connected to a resistive wire, in which case the equality $\mathcal{E}=w$ is indeed valid.

In Sec. 4, we study the problem of a wire moving through a static magnetic field. A particular situation where the equality $\mathcal{E}=w$ is valid is treated in Sec. 5.

Finally, Sec. 6 examines the case of a stationary wire inside a time-varying magnetic field. It is shown that the

equality $\mathcal{E}=w$ is satisfied only in the special case where the magnetic field varies linearly with time.

2. The general definitions of emf and work per unit charge

Consider a region of space in which an electromagnetic (e/m) field exists. In the most general sense, any *closed* path C (or *loop*) within this region will be called a “circuit” (whether or not the whole or parts of C consist of material objects such as wires, resistors, capacitors, batteries, etc.). We *arbitrarily* assign a positive direction of traversing the loop C , and we consider an element \vec{dl} of C oriented in the positive direction (Fig. 1).

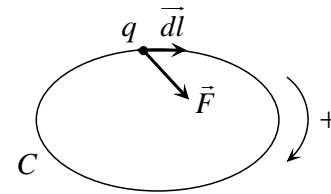

Figure 1: An oriented loop representing a circuit.

Imagine now a test charge q located at the position of \vec{dl} , and let \vec{F} be the force on q at time t . This force is exerted by the e/m field itself, as well as, possibly, by additional *energy sources* (e.g., batteries or some external mechanical action) that may contribute to the generation and preservation of a current flow around the loop C . The *force per unit charge* at the position of \vec{dl} at time t , is

$$\vec{f} = \frac{\vec{F}}{q} \quad (1)$$

Note that \vec{f} is independent of q , since the electromagnetic force on q is proportional to the charge. In particular, reversing the sign of q will have no effect on \vec{f} (although it will change the direction of \vec{F}).

In general, neither the shape nor the size of C is required to remain fixed. Moreover, the loop may be in motion rela-

tive to an external inertial observer. Thus, for a loop of (possibly) variable shape, size or position in space, we will use the notation $C(t)$ to indicate the state of the curve at time t .

We now define the *electromotive force* (emf) of the circuit C at time t as the line integral of \vec{f} along C , taken in the *positive* sense of C :

$$\mathcal{E}(t) = \oint_{C(t)} \vec{f}(\vec{r}, t) \cdot \vec{dl} \quad (2)$$

(where \vec{r} is the position vector of \vec{dl} relative to the origin of our coordinate system). Note that the sign of the emf is dependent upon our choice of the positive direction of circulation of C : by changing this convention, the sign of \mathcal{E} is reversed.

As mentioned above, the force (per unit charge) defined in (1) can be attributed to two factors: the interaction of q with the e/m field itself and the action on q due to any additional energy sources. Eventually, this latter interaction is *electromagnetic* in nature even when it originates from some external mechanical action. We write:

$$\vec{f} = \vec{f}_{em} + \vec{f}_{app} \quad (3)$$

where \vec{f}_{em} is the force due to the e/m field and \vec{f}_{app} is the *applied force* due to an additional energy source. We note that the force (3) does not include any *resistive* (dissipative) forces that oppose a charge flow along C ; it only contains forces that may contribute to the generation and preservation of such a flow in the circuit.

Now, suppose we allow a *single charge* q to make a full trip around the circuit C under the action of the force (3). In doing so, the charge describes a curve C' in space (not necessarily a closed one!) relative to an external inertial observer. Let \vec{dl}' be an element of C' representing an infinitesimal displacement of q in space, in time dt . We define the *work per unit charge* for this complete tour around the circuit by the integral:

$$w = \int_{C'} \vec{f} \cdot \vec{dl}' \quad (4)$$

For a *stationary* circuit of *fixed* shape, C' coincides with the closed curve C and (4) reduces to

$$w = \oint_C \vec{f} \cdot \vec{dl} \quad (\text{fixed } C) \quad (5)$$

It should be noted carefully that the integral (2) is evaluated *at a fixed time* t , while in the integrals (4) and (5) time is allowed to flow! In general, the value of w depends on the time t_0 and the point P_0 at which q starts its round trip on C . Thus, there is a certain ambiguity in the definition of work per unit charge. On the other hand, the ambiguity (so to

speak) with respect to the emf is related to the dependence of the latter on time t .

The question now is: can the emf be equal *in value* to the work per unit charge, despite the fact that these quantities are defined differently? For the equality $\mathcal{E}=w$ to hold, both \mathcal{E} and w must be defined unambiguously. Thus, \mathcal{E} must be *constant*, independent of time ($d\mathcal{E}/dt=0$) while w must not depend on the initial time t_0 or the initial point P_0 of the round trip of q on C . These requirements are *necessary conditions* in order for the equality $\mathcal{E}=w$ to be meaningful.

In the following sections we illustrate these ideas by means of several examples. As will be seen, the satisfaction of the above-mentioned conditions is the exception rather than the rule!

3. A resistive wire connected to a battery

Consider a circuit consisting of an ideal battery (i.e., one with no internal resistance) connected to a metal wire of total resistance R (Fig. 2). As shown in [1] (see also [2]), the emf of the circuit *in the direction of the current* is equal to the voltage V of the battery. Moreover, the emf in this case represents the work, per unit charge, done by the source (battery). Let us review the proof of these statements.

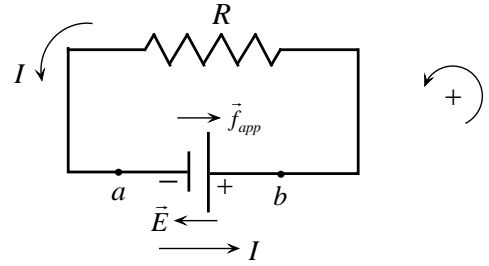

Figure 2: A battery connected to a resistive wire.

A (*conventionally positive*) moving charge q is subject to two forces around the circuit C : an electrostatic force $\vec{F}_e = q\vec{E}$ at every point of C and a force \vec{F}_{app} inside the battery, the latter force carrying q from the negative pole a to the positive pole b *through the source*. According to (3), the total force per unit charge is

$$\vec{f} = \vec{f}_e + \vec{f}_{app} = \vec{E} + \vec{f}_{app} .$$

The emf in the direction of the current (i.e., counterclockwise), at any time t , is

$$\begin{aligned} \mathcal{E} &= \oint_C \vec{f} \cdot \vec{dl} \\ &= \oint_C \vec{E} \cdot \vec{dl} + \oint_C \vec{f}_{app} \cdot \vec{dl} \\ &= \int_a^b \vec{f}_{app} \cdot \vec{dl} \end{aligned} \quad (6)$$

where we have used the facts that $\oint_C \vec{E} \cdot d\vec{l} = 0$ for an electrostatic field and that the action of the source on q is limited to the region between the poles of the battery.

Now, in a steady-state situation ($I = \text{constant}$) the charge q moves at constant speed along the circuit. This means that the total force on q in the direction of the path C is zero. In the interior of the wire, the electrostatic force $\vec{F}_e = q\vec{E}$ is counterbalanced by the resistive force on q due to the collisions of the charge with the positive ions of the metal (as mentioned previously, this latter force does *not* contribute to the emf). In the interior of the (ideal) battery, however, where there is no resistance, the electrostatic force must be counterbalanced by the opposing force exerted by the source. Thus, in the section of the circuit between a and b , $\vec{f}_{app} = -\vec{f}_e = -\vec{E}$. By (6), then, we have:

$$\mathcal{E} = -\int_a^b \vec{E} \cdot d\vec{l} = V_b - V_a = V \quad (7)$$

where V_a and V_b are the electrostatic potentials at a and b , respectively. We note that the emf is constant in time, as expected in a steady-state situation.

Next, we want to find the work per unit charge for a complete tour around the circuit. To this end, we allow a *single charge* q to make a full trip around C and we use expression (5) (since the wire is stationary and of fixed shape). In applying this relation, time is assumed to flow as q moves along C . Given that the situation is static (time-independent), however, time is not really an issue since it doesn't matter at what moment the charge will pass by any given point of C . Thus, the integration in (5) will yield the same result (7) as the integration in (6), despite the fact that, in the latter case, time was assumed *fixed*. We conclude that the equality $w = \mathcal{E}$ is valid in this case: the emf *does* represent work per unit charge.

4. Moving wire inside a static magnetic field

Consider a wire C moving in the xy -plane. The shape and/or size of the wire need not remain fixed during its motion. A static magnetic field $\vec{B}(\vec{r})$ is present in the region of space where the wire is moving. For simplicity, we assume that this field is normal to the plane of the wire and directed *into* the page.

In Fig. 3, the z -axis is normal to the plane of the wire and directed towards the reader. We call \vec{da} an infinitesimal normal vector representing an element of the plane surface bounded by the wire (this vector is directed *into* the plane, consistently with the chosen clockwise direction of traversing the loop C). If \hat{u}_z is the unit vector on the z -axis, then $\vec{da} = -(da)\hat{u}_z$ and $\vec{B} = -B(\vec{r})\hat{u}_z$, where $B(\vec{r}) = |\vec{B}(\vec{r})|$.

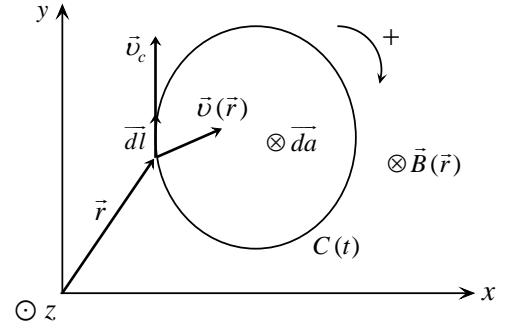

Figure 3: A wire C moving inside a static magnetic field.

Consider an element \vec{dl} of the wire, located at a point with position vector \vec{r} relative to the origin of our inertial frame of reference. Call $\vec{v}(\vec{r})$ the velocity of this element relative to our frame. Let q be a (*conventionally positive*) charge passing by the considered point at time t . This charge executes a composite motion, having a velocity \vec{v}_c *along the wire* and acquiring an extra velocity $\vec{v}(\vec{r})$ due to the motion of the wire itself. The total velocity of q relative to us is $\vec{v}_{tot} = \vec{v}_c + \vec{v}$.

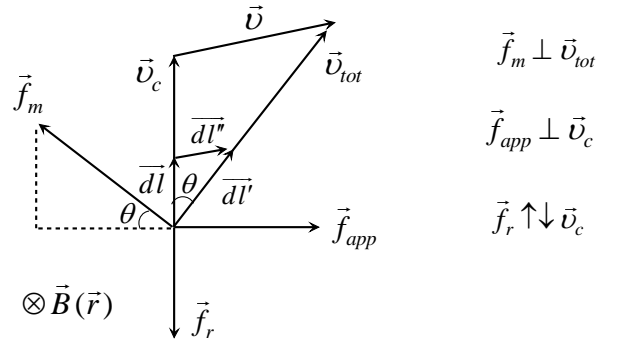

Figure 4: Balance of forces per unit charge.

The balance of forces acting on q is shown in the diagram of Fig. 4. The *magnetic force* on q is normal to the charge's total velocity and equal to $\vec{F}_m = q(\vec{v}_{tot} \times \vec{B})$. Hence, the magnetic force per unit charge is $\vec{f}_m = \vec{v}_{tot} \times \vec{B}$. Its component along the wire (i.e., in the direction of \vec{dl}) is counterbalanced by the *resistive force* \vec{f}_r , which opposes the motion of q along C (this force, as mentioned previously, does *not* contribute to the emf). However, the component of the magnetic force *normal* to the wire will tend to make the wire move "backwards" (in a direction opposing the desired motion of the wire) unless it is counterbalanced by some *external mechanical action* (e.g., our hand, which pulls the wire forward). Now, the charge q takes a share of this action by means of some force transferred to it by the structure of the wire. This force (which will be called an *applied force*) must be *normal* to the wire (in order to counterbalance the normal component of the magnetic force). We denote the

applied force per unit charge by \vec{f}_{app} . Although this force originates from an external mechanical action, it is delivered to q through an *electromagnetic* interaction with the crystal lattice of the wire (not to be confused with the resistive force, whose role is different!).

According to (3), the total force contributing to the emf of the circuit is $\vec{f} = \vec{f}_m + \vec{f}_{app}$. By (2), the emf at time t is

$$\mathcal{E}(t) = \oint_{C(t)} \vec{f}_m \cdot \vec{dl} + \oint_{C(t)} \vec{f}_{app} \cdot \vec{dl}.$$

The second integral vanishes since the applied force is normal to the wire element at every point of C . The integral of the magnetic force is equal to

$$\oint_C (\vec{v}_{tot} \times \vec{B}) \cdot \vec{dl} = \oint_C (\vec{v}_c \times \vec{B}) \cdot \vec{dl} + \oint_C (\vec{v} \times \vec{B}) \cdot \vec{dl}.$$

The first integral on the right vanishes, as can be seen by inspecting Fig. 4. Thus, we finally have:

$$\mathcal{E}(t) = \oint_{C(t)} [\vec{v}(\vec{r}) \times \vec{B}(\vec{r})] \cdot \vec{dl} \quad (8)$$

As shown analytically in [1, 2], the emf of C is equal to

$$\mathcal{E}(t) = - \frac{d}{dt} \Phi_m(t) \quad (9)$$

where we have introduced the *magnetic flux* through C ,

$$\Phi_m(t) = \int_{S(t)} \vec{B}(\vec{r}) \cdot \vec{da} = \int_{S(t)} B(\vec{r}) da \quad (10)$$

[By $S(t)$ we denote *any* open surface bounded by C at time t ; e.g., the plane surface enclosed by the wire.]

Now, let C' be the path of q in space relative to the external observer, for a full trip of q around the wire (in general, C' will be an *open* curve). According to (4), the work done per unit charge for this trip is

$$w = \int_{C'} \vec{f}_m \cdot \vec{dl}' + \int_{C'} \vec{f}_{app} \cdot \vec{dl}'.$$

The first integral vanishes (cf. Fig. 4), while for the second one we notice that

$$\vec{f}_{app} \cdot \vec{dl}' = \vec{f}_{app} \cdot \vec{dl} + \vec{f}_{app} \cdot \vec{dl}'' = \vec{f}_{app} \cdot \vec{dl}''$$

(since the applied force is normal to the wire element everywhere; see Fig. 4). Thus we finally have:

$$w = \int_{C'} \vec{f}_{app} \cdot \vec{dl}' \quad (11a)$$

with

$$\vec{f}_{app} \cdot \vec{dl}' = \vec{f}_{app} \cdot \vec{dl}'' = \vec{f}_{app} \cdot \vec{v} dt \quad (11b)$$

where $\vec{dl}'' = \vec{v} dt$ is the infinitesimal displacement of the wire element in time dt .

5. An example: Motion inside a uniform magnetic field

Consider a metal bar (ab) of length h , sliding parallel to itself with constant speed v on two parallel rails that form part of a U-shaped wire, as shown in Fig. 5. A *uniform* magnetic field \vec{B} , pointing into the page, fills the entire region.

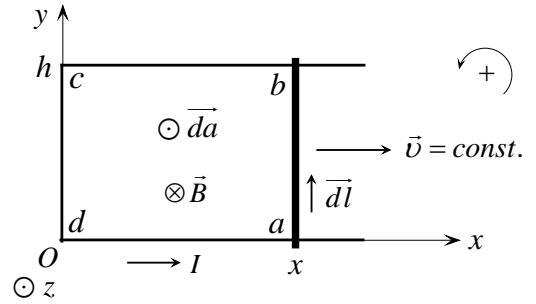

Figure 5: A metal bar (ab) sliding on two parallel rails that form part of a U-shaped wire.

A circuit $C(t)$ of variable size is formed by the rectangular loop ($abcda$). The field and the surface element are written, respectively, as $\vec{B} = -B \hat{u}_z$ (where $B = |\vec{B}| = \text{const.}$) and $\vec{da} = (da) \hat{u}_z$ (note that the direction of traversing the loop C is now counterclockwise).

The general diagram of Fig. 4, representing the balance of forces, reduces to the one shown in Fig. 6. Note that this latter diagram concerns only the *moving* part (ab) of the circuit, since it is in this part only that the velocity \vec{v} and the applied force \vec{f}_{app} are nonzero.

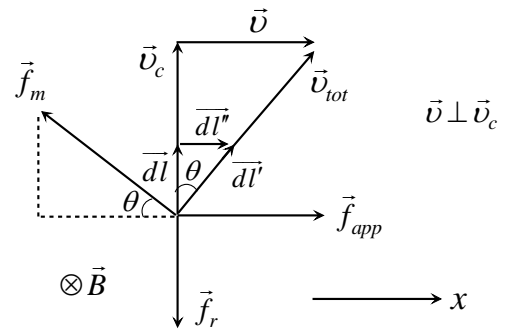

Figure 6: Balance of forces per unit charge.

The emf of the circuit at time t is, according to (8),

$$\mathcal{E}(t) = \oint_{C(t)} (\vec{v} \times \vec{B}) \cdot \vec{dl}$$

$$= \int_a^b vB dl = vB \int_a^b dl = vBh .$$

Alternatively, the magnetic flux through C is

$$\begin{aligned} \Phi_m(t) &= \int_{S(t)} \vec{B}(\vec{r}) \cdot \vec{da} = - \int_{S(t)} B da = -B \int_{S(t)} da \\ &= -Bhx \end{aligned}$$

(where x is the momentary position of the bar at time t), so that

$$\mathcal{E}(t) = - \frac{d}{dt} \Phi_m(t) = Bh \frac{dx}{dt} = Bhv .$$

We note that the emf is constant (time-independent).

Next, we want to use (11) to evaluate the work per unit charge for a complete tour of a charge around C . Since the applied force is nonzero only on the section (ab) of C , the path of integration, C' (which is a straight line, given that the charge moves at constant velocity in space) will correspond to the motion of the charge along the metal bar only, i.e., from a to b . (Since the bar is being displaced in space while the charge is traveling along it, the line C' will *not* be parallel to the bar.) According to (11),

$$\begin{aligned} w &= \int_{C'} \vec{f}_{app} \cdot \vec{dl}' \quad \text{with} \\ \vec{f}_{app} \cdot \vec{dl}' &= \vec{f}_{app} \cdot \vec{dl}'' = f_{app} dl'' = f_{app} v dt \end{aligned}$$

(cf. Fig. 6). Now, the role of the applied force is to counterbalance the x -component of the magnetic force in order that the bar may move at constant speed in the x direction. Thus,

$$f_{app} = f_m \cos \theta = v_{tot} B \cos \theta = Bv_c$$

and

$$f_{app} v dt = Bv v_c dt = Bv dl$$

(since $v_c dt$ represents an elementary displacement dl of the charge along the metal bar in time dt). We finally have:

$$w = \int_a^b Bv dl = Bv \int_a^b dl = Bvh .$$

We note that, in this specific example, the value of the work per unit charge is equal to that of the emf, both these quantities being constant and unambiguously defined. This would *not* have been the case, however, if the magnetic field were *nonuniform*!

6. Stationary wire inside a time-varying magnetic field

Our final example concerns a *stationary* wire C inside a *time-varying* magnetic field of the form $\vec{B}(\vec{r}, t) = -B(\vec{r}, t) \hat{u}_z$ (where $B(\vec{r}, t) = |\vec{B}(\vec{r}, t)|$), as shown in Fig. 7.

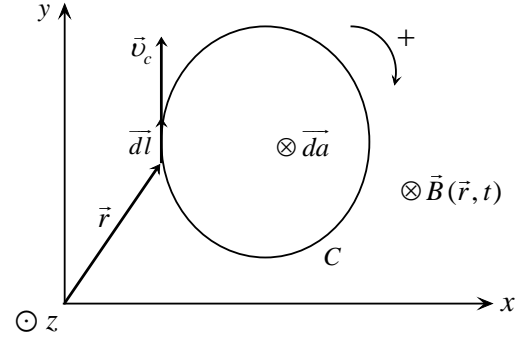

Figure 7: A stationary wire C inside a time-varying magnetic field.

As is well known [1-7], the presence of a time-varying magnetic field implies the presence of an electric field \vec{E} as well, such that

$$\vec{\nabla} \times \vec{E} = - \frac{\partial \vec{B}}{\partial t} \quad (12)$$

As discussed in [1], the emf of the circuit at time t is given by

$$\mathcal{E}(t) = \oint_C \vec{E}(\vec{r}, t) \cdot \vec{dl} = - \frac{d}{dt} \Phi_m(t) \quad (13)$$

where

$$\Phi_m(t) = \int_S \vec{B}(\vec{r}, t) \cdot \vec{da} = \int_S B(\vec{r}, t) da \quad (14)$$

is the magnetic flux through C at this time.

On the other hand, the work per unit charge for a full trip around C is given by (5): $w = \oint_C \vec{f} \cdot \vec{dl}$, where $\vec{f} = \vec{f}_{em} = \vec{E} + (\vec{v}_c \times \vec{B})$, so that

$$w = \oint_C \vec{E} \cdot \vec{dl} + \oint_C (\vec{v}_c \times \vec{B}) \cdot \vec{dl} .$$

As is easy to see (cf. Fig. 7), the second integral vanishes, thus we are left with

$$w = \oint_C \vec{E} \cdot \vec{dl} \quad (15)$$

The similarity of the integrals in (13) and (15) is deceptive! The integral in (13) is evaluated *at a fixed time* t , while in (15) time is allowed to flow as the charge moves along C . Is it, nevertheless, possible that the *values* of these integrals coincide? As mentioned at the end of Sec. 2, a necessary condition for this to be the case is that the two integrations yield time-independent results. In order that \mathcal{E} be time-independent (but nonzero), the magnetic flux (14) – thus the magnetic field itself – must increase *linearly* with time. On the other hand, the integration (15) for w will be time-independent if so is the electric field. By (12), then, the magnetic field must be linearly dependent on time, which brings us back to the previous condition.

As an example, assume that the magnetic field is of the form

$$\vec{B} = -B_0 t \hat{u}_z \quad (B_0 = \text{const.}).$$

A possible solution of (12) for \vec{E} is, in cylindrical coordinates,

$$\vec{E} = \frac{B_0 \rho}{2} \hat{u}_\phi.$$

[We assume that these solutions are valid in a limited region of space (e.g., in the interior of a solenoid whose axis coincides with the z -axis) so that ρ is finite in the region of interest.] Now, consider a circular wire C of radius R , centered at the origin of the xy -plane. Then, given that $\vec{dl} = -(dl)\hat{u}_\phi$,

$$\mathcal{E} = \oint_C \vec{E} \cdot \vec{dl} = -\frac{B_0 R}{2} \oint_C dl = -B_0 \pi R^2.$$

Alternatively,

$$\Phi_m = \int_S B da = B_0 \pi R^2 t,$$

so that $\mathcal{E} = -d\Phi_m / dt = -B_0 \pi R^2$. We anticipate that, due to the time constancy of the electric field, the same result will be found for the work w by using (15).

7. Concluding remarks

No single, universally accepted definition of the emf seems to exist in the literature of Electromagnetism. The definition given in this article (as well as in [1]) comes close to those of [2] and [3]. In particular, by using an example similar to that of Sec. 5 in this paper, Griffiths [2] makes a clear distinction between the concepts of emf and work per unit charge. In [4] and [5] (as well as in numerous other textbooks) the emf is identified with work per unit charge, in general, while in [6] and [7] it is defined as a closed line integral of the non-conservative part of the electric field that accompanies a time-varying magnetic flux.

The balance of forces and the origin of work in a conducting circuit moving through a magnetic field are nicely discussed in [2, 8, 9]. An interesting approach to the relation between work and emf, utilizing the concept of virtual work, is described in [10].

Of course, the list of references cited above is by no means exhaustive. It only serves to illustrate the diversity of ideas concerning the concept of the emf. The subtleties inherent in this concept make it an interesting subject of study for both the researcher and the advanced student of classical Electrodynamics.

References

- [1] C. J. Papachristou, A. N. Magoulas, *Electromotive force: A guide for the perplexed*, Annals Nav. Acad. Gr. (Nausivios Chora) Vol. 5 (2014), in press. See also: <http://arxiv.org/abs/1211.6463>.
- [2] D. J. Griffiths, *Introduction to Electrodynamics*, 3rd Edition (Prentice-Hall, 1999).
- [3] W. N. Cottingham, D. A. Greenwood, *Electricity and Magnetism* (Cambridge, 1991).
- [4] D. M. Cook, *The Theory of the Electromagnetic Field* (Dover, 2003).
- [5] R. K. Wangsness, *Electromagnetic Fields*, 2nd Edition (Wiley, 1986).
- [6] J. D. Jackson, *Classical Electrodynamics*, 2nd Edition (Wiley, 1975).
- [7] W. K. H. Panofsky, M. Phillips, *Classical Electricity and Magnetism*, 2nd Edition (Addison-Wesley, 1962).
- [8] E. P. Mosca, *Magnetic forces doing work?*, Am. J. Phys. 42 (1974) 295.
- [9] J. A. Redinz, *Forces and work on a wire in a magnetic field*, Am. J. Phys. 79 (2011) 774.
- [10] R. A. Diaz, W. J. Herrera, S. Gomez, *The role of the virtual work in Faraday's Law*, <http://arxiv.org/abs/1104.1718>.

Some aspects of the electromotive force: Educational review article

Costas J. Papachristou
Hellenic Naval Academy

Synopsis

Certain aspects of the concept of the electromotive force (emf) of a "circuit", as this concept was defined in recent publications, are discussed. In particular, the independence of the emf from the conductivity of the circuit is explained and the role of the applied force in motional emf is analyzed.

C. J. PAPACHRISTOU - A. N. MAGOULAS

SOME ASPECTS OF THE
ELECTROMOTIVE FORCE

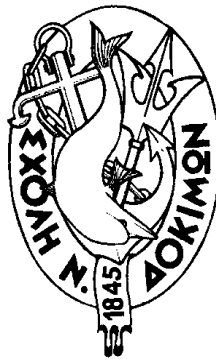

HELLENIC NAVAL ACADEMY
2016

Some aspects of the electromotive force

C. J. Papachristou *, A. N. Magoulas **

* *Department of Physical Sciences, Hellenic Naval Academy, Piraeus 18539, Greece*
E-mail: papachristou@snd.edu.gr

** *Department of Electrical Engineering, Hellenic Naval Academy, Piraeus 18539, Greece*
E-mail: aris@snd.edu.gr

Certain aspects of the concept of the electromotive force (emf) of a “circuit”, as this concept was defined in recent publications, are discussed. In particular, the independence of the emf from the conductivity of the circuit is explained and the role of the applied force in motional emf is analyzed.

1. Definition and analytical expression of the emf

In recent articles [1,2] we studied the concept of the *electromotive force (emf)* of a “circuit” and examined the extent to which the emf represents work per unit charge for a complete tour around the circuit. This educational note contains some additional remarks regarding the emf; it may be regarded as an addendum to the aforementioned publications.

We consider a closed path C (or *loop*) in a region of space where an electromagnetic (e/m) field exists (Fig. 1). Generally speaking, this loop will be called a “*circuit*” if a charge flow can be sustained on it. We *arbitrarily* assign a positive direction of traversing the loop C and we consider an element \overline{dl} of C oriented in the positive direction.

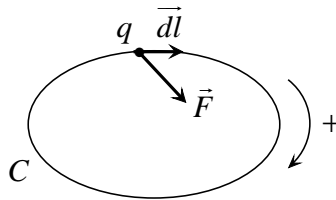

Figure 1

Let q be a *test charge*, which at time t is located at the position of \overline{dl} , and let \vec{F} be the force on q at this time. The force \vec{F} is exerted by the e/m field itself as well as, possibly, by additional *energy sources* (such as batteries or some external mechanical action) that may contribute to the generation and preservation of a current around the loop C . The *force per unit charge* at the position of \overline{dl} , at time t , is $\vec{f} = \vec{F} / q$. We note that \vec{f} is independent of q since the e/m force on a charge is proportional to the charge.

Since, in general, neither the shape nor the size of C is required to remain fixed, and since the loop may also be in motion relative to an external observer, we will use

the notation $C(t)$ to indicate the state, at time t , of a circuit of generally variable shape, size or position in space.

The *electromotive force (emf)* of the circuit C at time t is defined as the line integral of \vec{f} along C , taken in the *positive* sense of C :

$$\mathcal{E}(t) = \oint_{C(t)} \vec{f}(\vec{r}, t) \cdot \overline{d\vec{l}} \quad (1)$$

where \vec{r} is the position vector of $\overline{d\vec{l}}$ relative to the origin of our coordinate system. Obviously, the sign of the emf is dependent upon our choice of the positive direction of circulation of C . It should be noted carefully that the integral (1) is evaluated *at a given time* t . Thus, the force \vec{f} must be measured *simultaneously*, at time t , at all points of C .

The force \vec{f} can be attributed to two factors: (a) the interaction of q with the existing e/m field itself; and (b) the action on q by any additional energy sources that may be necessary in order to maintain a steady flow of charge on C . (This latter interaction also is *electromagnetic* in nature, even when it originates from some external mechanical action.) We write

$$\vec{f} = \vec{f}_{em} + \vec{f}_{app} \quad (2)$$

where \vec{f}_{em} is the force due to the e/m field and \vec{f}_{app} is the *applied force* due to an additional energy source.

Two familiar cases of emf-driven circuits where an additional applied force is required are the following:

1. In a battery-resistor circuit [1-3] an applied force is necessary in order to carry a (conventionally *positive*) mobile charge from the negative to the positive pole of the battery, *through* the source. This force is provided by the battery itself.

2. In the case of a closed metal wire C moving in a time-independent magnetic field [2-5] the current on C is sustained for as long as the motion of C continues. This, in turn, necessitates the action of an external force on C (say, by our hand), as will be explained in Sec. 4.

Now, by (1) and (2),

$$\mathcal{E}(t) = \oint_{C(t)} \vec{f}_{em} \cdot \overline{d\vec{l}} + \oint_{C(t)} \vec{f}_{app} \cdot \overline{d\vec{l}} \equiv \mathcal{E}_{em}(t) + \mathcal{E}_{app}(t) \quad (3)$$

We would like to find an analytical expression for $\mathcal{E}_{em}(t)$. So, let $(\vec{E}(\vec{r}, t), \vec{B}(\vec{r}, t))$ be the e/m field in the region of space where the loop $C(t)$ is lying. Let q be a test charge located, at time t , at the position of $\overline{d\vec{l}}$ and let \vec{v}_{tot} be the total velocity of q in space, relative to some inertial frame of reference. We write

$$\vec{v}_{tot} = \vec{v} + \vec{v}_c$$

where \vec{v}_c is the velocity of q along C (i.e., in a direction parallel to \vec{dl}) while \vec{v} is the velocity of \vec{dl} itself due to a possible motion in space, or just a deformation over time, of the loop $C(t)$ as a whole. The total e/m force on q is

$$\vec{F}_{em} = q[\vec{E} + (\vec{v}_{tot} \times \vec{B})] ,$$

so that

$$\vec{f}_{em} = \frac{\vec{F}}{q} = \vec{E} + [(\vec{v} + \vec{v}_c) \times \vec{B}] .$$

Hence,

$$\mathcal{E}_{em}(t) = \oint_{C(t)} \vec{E} \cdot \vec{dl} + \oint_{C(t)} (\vec{v} \times \vec{B}) \cdot \vec{dl} + \oint_{C(t)} (\vec{v}_c \times \vec{B}) \cdot \vec{dl} .$$

Given that \vec{v}_c is parallel to \vec{dl} , the last integral on the right vanishes. Thus, finally,

$$\mathcal{E}_{em}(t) = \oint_{C(t)} \vec{E}(\vec{r}, t) \cdot \vec{dl} + \oint_{C(t)} [\vec{v}(\vec{r}, t) \times \vec{B}(\vec{r}, t)] \cdot \vec{dl} \equiv \mathcal{E}_e(t) + \mathcal{E}_m(t) \quad (4)$$

We note that, in our definition of the emf, the force per unit charge was defined as $\vec{f} = \vec{F}/q$, assuming that a replica of a test charge q is placed at every point of the circuit and that the forces \vec{F} on all test charges are measured *simultaneously* at time t . Now, in the case of a conducting loop C (say, a metal wire) it is reasonable to identify q with one of the (conventionally positive) mobile free electrons. This particular identification, although logical for practical purposes, is nevertheless not necessary, given that the force \vec{f} is eventually independent of q . Thus, in general, q may just be considered as a *hypothetical* test charge that is not necessarily identified with an actual mobile charge.

2. Independence from conductivity

Let $C(t)$ be a conducting loop (say, a metal wire) inside a given e/m field. The emf of C at time t is given by (3) and (4). We note from (4) that the part \mathcal{E}_{em} of the total emf is independent of the velocity \vec{v}_c of q along C (where q may be conveniently – although not necessarily – assumed to be a mobile free electron of the conductor, conventionally considered as a *positive* charge). We may physically interpret this as follows:

The e/m field creates an emf \mathcal{E}_{em} that tends to generate a charge flow on C . However, this emf does not by itself determine *how fast* the mobile charges move along C . Presumably, this will depend on physical properties of the path C that are associated with its *conductivity*. (For example, in a battery-resistance circuit the potential difference at the ends of the resistance – thus the value of the electric field inside the conductor – does not by itself determine the velocity \vec{v}_c of the mobile charges along the

circuit, since this velocity is related to the current generated by the source, which current depends, in turn, on the resistance of the circuit, according to Ohm's law.)

Now, the role of the part \mathcal{E}_{app} of the total emf (3) is to *maintain* the charge flow on $C(t)$ that is generated by \mathcal{E}_{em} . We thus anticipate that \mathcal{E}_{app} will also be independent of \vec{v}_c (this is, e.g., the case in our previous example, where \mathcal{E}_{app} is equal to the voltage of the battery [1-3]). In conclusion,

the total emf $\mathcal{E}(t)$ of a conducting loop $C(t)$ is not dependent upon the velocity of motion of the mobile charges q along the loop.

This leads us to a further conclusion:

The total emf $\mathcal{E}(t)$ of a conducting loop $C(t)$ inside an e/m field is not dependent upon the conductivity of the loop.

This can be justified by noting that, by its definition, the force (2) does not include contributions from *resistive forces* that oppose a charge flow on C ; it only contains e/m interactions that may contribute to the generation and preservation of a current in the circuit. Note, however, that the *current* itself *does* depend on the *conductivity* σ of C , according to Ohm's law ($\vec{J} = \sigma \vec{f}$) [3].

Alternatively, as argued above, the emf does not depend on \vec{v}_c . Now, in a steady-state situation under given electrodynamic conditions (thus, for a given \vec{f}) this velocity is a linear function of the *mobility* μ of q , according to the empirical relation $\vec{v}_c = \mu \vec{f}$ (by which Ohm's law is deduced). On the other hand, the conductivity of C is given by $\sigma = qn\mu$. The *density* n of mobile charges, as well as the value of q , cannot affect the value of the emf since that quantity is defined per unit charge. We thus conclude that the emf of C cannot depend on μ , as well as on n and q ; hence, \mathcal{E} is independent of σ .

3. Emf and the Faraday-Henry law

Consider a region of space in which a (generally time-dependent) e/m field (\vec{E}, \vec{B}) exists. Let C be a *fixed* conducting loop in this region. There is no additional applied force on C , so (3) reduces to $\mathcal{E}(t) = \mathcal{E}_{em}(t)$. Furthermore, since C is stationary, $\vec{v}(\vec{r}, t)$ vanishes identically and, by (4), $\mathcal{E}_m(t) = 0$ and $\mathcal{E}_{em}(t) = \mathcal{E}_e(t)$. Thus, finally,

$$\mathcal{E}(t) = \oint_C \vec{E}(\vec{r}, t) \cdot \overline{d\vec{l}} \quad (5)$$

By Stokes' theorem,

$$\oint_C \vec{E} \cdot \overline{d\vec{l}} = \int_S (\vec{\nabla} \times \vec{E}) \cdot \overline{d\vec{a}}$$

where S is any open surface bounded by C (Fig. 2).

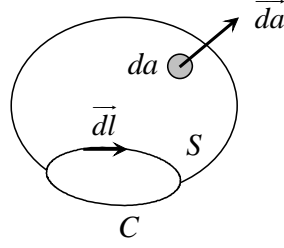

Figure 2

Moreover, by the *Faraday-Henry law*,

$$\vec{\nabla} \times \vec{E} = -\frac{\partial \vec{B}}{\partial t} \quad (6)$$

So, (5) yields

$$\mathcal{E}(t) = -\frac{d}{dt} \int_S \vec{B} \cdot \vec{da} = -\frac{d}{dt} \Phi_m(t) \quad (7)$$

where

$$\Phi_m(t) = \int_S \vec{B}(\vec{r}, t) \cdot \vec{da}$$

is the *magnetic flux* through C at time t . As commented in [1], relation (7) expresses a genuine physical law, not a mere consequence of the definition of the emf.

4. Motional emf due to a static magnetic field

Let $C(t)$ be a conducting loop inside a static magnetic field $\vec{B}(\vec{r})$ (Fig. 3). The time dependence of C indicates a motion and/or a deformation of the loop over time. We will show that the emf of C at time t is given by the expression

$$\mathcal{E}(t) = \mathcal{E}_m(t) = \oint_{C(t)} [\vec{v}(\vec{r}) \times \vec{B}(\vec{r})] \cdot \vec{dl} \quad (8)$$

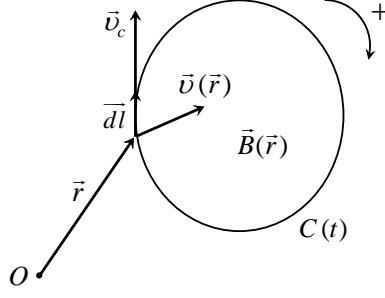

Figure 3

Let q be a mobile charge (say, a conventionally *positive* free electron) located at the position \vec{r} (relative to our coordinate system) of the loop element \vec{dl} at time t . As in Sec. 1, we denote the velocity of \vec{dl} with respect to our frame of reference by $\vec{v}(\vec{r})$, the velocity of q along C by \vec{v}_c , and the total velocity of q relative to our frame by $\vec{v}_{tot} = \vec{v} + \vec{v}_c$.

Since there is no electric field in the region of interest,

$$\mathcal{E}_e(t) \equiv \oint_C \vec{E}(\vec{r}, t) \cdot \vec{dl} = 0 \quad \text{and} \quad \mathcal{E}_{em}(t) = \mathcal{E}_m(t) \quad (9)$$

Also, if \vec{f}_{app} is the applied force per unit charge at the position of q , at time t ,

$$\mathcal{E}_{app}(t) = \oint_{C(t)} \vec{f}_{app}(\vec{r}, t) \cdot \vec{dl} \quad (10)$$

The role of the applied force is to keep the current flowing. This will happen for as long as the loop C is moving or/and deforming, so that $\vec{v}(\vec{r})$ is not identically zero for all t . Why is an external force needed to keep C moving or deforming? Let us carefully analyze the situation.

The magnetic force on q is

$$\vec{F}_m = q(\vec{v}_{tot} \times \vec{B}) \quad \text{so that} \quad \vec{f}_m = \vec{v}_{tot} \times \vec{B} .$$

Now, imagine a temporary, local 3-dimensional rectangular system of axes (x, y, z) at the location \vec{r} of q at time t . We assume, without loss of generality, that the z -axis is in the direction of \vec{dl} . (The orientation of the mutually perpendicular x and y -axes on the plane normal to the z -axis may be chosen arbitrarily.) Then we may write

$$\vec{f}_m = \vec{f}_{m,x} + \vec{f}_{m,y} + \vec{f}_{m,z} \equiv \vec{f}_c + \vec{f}_\perp$$

where $\vec{f}_c = \vec{f}_{m,z}$ is the component of the magnetic force *along* the loop (i.e., in a direction parallel to \vec{dl}) while $\vec{f}_\perp = \vec{f}_{m,x} + \vec{f}_{m,y}$ is the component *normal* to the loop (thus to \vec{dl}).

In a steady-state situation (steady current flow) \vec{f}_c is counterbalanced by the resistive force that opposes charge motion along C (as mentioned before, this latter force does not contribute to the emf). However, to counterbalance the normal component \vec{f}_\perp some external action (say, by our hand that moves or deforms the loop C) is needed in order for C to keep moving or deforming. This is precisely what the applied force \vec{f}_{app} does. Clearly, this force must be *normal* to C at each point of the loop. From (10) we then conclude that

$$\mathcal{E}_{app}(t) = 0 .$$

Combining this with (3), (4) and (9), we finally verify the validity of (8).

It can be shown [1,3] directly from (8) that

$$\mathcal{E}(t) = - \frac{d}{dt} \Phi_m(t) \tag{11}$$

where $\Phi_m(t)$ is the magnetic flux through C at time t . This *looks like* (7) for a fixed geometrical loop in a time-dependent e/m field, although the origins of the two relations are different. Indeed, equation (11) is a direct consequence of the definition of the emf and may be derived from (8) essentially by mathematical manipulation (see, e.g., the Appendix in [1]). On the contrary, to derive (7) the Faraday-Henry law (6) was used. This is an *experimental* law, hence so is the expression (7) for the emf. In other words, relation (7) is not a mere mathematical consequence of the definition of the emf.

5. An example

Consider a metal bar (ab) of length h , sliding parallel to itself with constant speed v on two parallel rails that form part of a U-shaped wire, as shown in Fig. 4. A *uniform* magnetic field \vec{B} , pointing into the page, fills the entire region. A circuit $C(t)$ of variable size is formed by the rectangular loop ($abcd$).

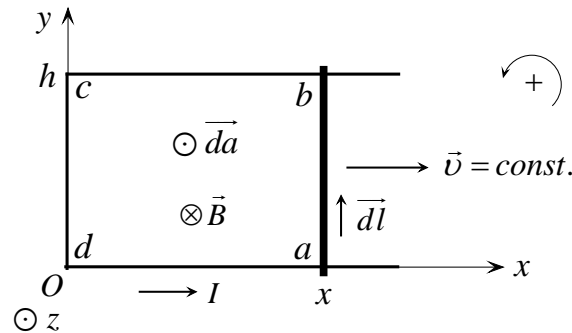

Figure 4

In Fig. 4, the z -axis is normal to the plane of the wire and directed toward the reader. We call \vec{da} an infinitesimal normal vector representing an element of the plane surface bounded by the wire (this vector is directed toward the reader, consistently with the chosen counterclockwise direction of traversing the loop C). If \hat{u}_z is the unit vector on the z -axis, then the field and the surface element are written, respectively, as $\vec{B} = -B\hat{u}_z$ (where $B = |\vec{B}| = \text{const.}$) and $\vec{da} = (da)\hat{u}_z$.

The balance of forces is shown in Fig. 5 (by \vec{f}_r we denote the resistive force per unit charge, which does not contribute to the emf). Note that this diagram concerns only the *moving* part (ab) of the circuit, since it is in this part only that the velocity \vec{v} and the applied force \vec{f}_{app} are nonzero.

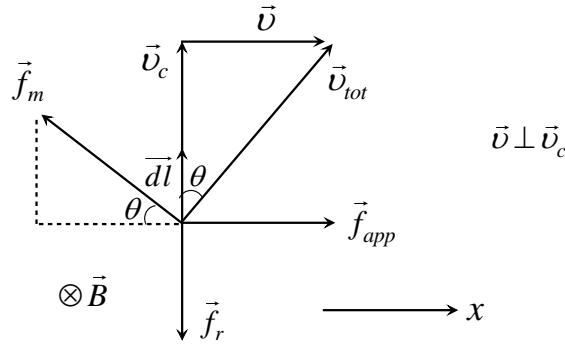

Figure 5

The emf of the circuit at time t is, according to (8),

$$\mathcal{E}(t) = \oint_{C(t)} (\vec{v} \times \vec{B}) \cdot \vec{dl} = \int_a^b vB dl = vB \int_a^b dl = vBh .$$

Alternatively, the magnetic flux through C is

$$\Phi_m(t) = \int_{S(t)} \vec{B} \cdot \vec{da} = - \int_{S(t)} B da = -B \int_{S(t)} da = -Bhx$$

(where x is the momentary position of the bar at time t) so that, by (11),

$$\mathcal{E}(t) = - \frac{d}{dt} \Phi_m(t) = Bh \frac{dx}{dt} = Bhv .$$

Now, the role of the applied force is to counterbalance the x -component of the magnetic force in order that the bar may move at constant speed in the x direction. Thus,

$$f_{app} = f_m \cos \theta = v_{tot} B \cos \theta = Bv_c .$$

We note that, although f_{app} depends on the speed v_c of a mobile charge along the bar, the associated part of the emf is itself independent of v_c ! Specifically, as argued in

Sec. 4, $\mathcal{E}_{app}(t)=0$. On the other hand, in this particular example the work w of f_{app} for a complete tour around the circuit is equal to the total emf (cf. [2]): $w=\mathcal{E}=Bhv$. This equality, however, is accidental and does not reflect a more general relation between the work per unit charge and the emf. (Another such “accidental” case is the battery-resistance circuit [1-3].)

6. Summary

This article is an addendum to our study of the concept of the electromotive force (emf), as this concept was pedagogically approached in previous publications [1,2]. We have focused on some particular aspects of the subject that we felt are important enough to merit further discussion. Let us review them:

1. For a conducting loop C inside an e/m field, we explained why the emf of C does not depend on the conductivity of the loop. As “obvious” as this statement may seem, one still needs to justify it physically and to demonstrate its consistency with Ohm’s law.

2. We expressed the Faraday-Henry law in terms of the emf of a closed conducting curve inside a time-dependent e/m field.

3. We studied the case of motional emf in some detail (see also [2-5]). Particularly important is the role of the applied force in this case. In addition to analyzing this role and, in the process, deriving an explicit expression for the emf, we explained why the physics of the situation is different from that of the Faraday-Henry law, despite the similar-looking forms of the emf in the two cases. Of course, as Relativity has shown, this similarity is anything but coincidental!

References

1. C. J. Papachristou and A. N. Magoulas, *Electromotive force: A guide for the perplexed*, Nausivios Chora (Annals Nav. Acad. Gr.) Vol. 5 (2014) pp. C3-C13 (<http://nausivios.snd.edu.gr/docs/2014C.pdf>); see also arXiv:1211.6463 (<http://arxiv.org/abs/1211.6463>).
2. C. J. Papachristou and A. N. Magoulas, *Does the electromotive force (always) represent work?*, *Advanced Electromagnetics*, Vol. 4, No. 1 (2015), pp. 10-15 (http://www.aemjournal.org/index.php/AEM/article/view/257/pdf_44).
3. D. J. Griffiths, *Introduction to Electrodynamics*, 3rd Edition (Prentice-Hall, 1999).
4. E. P. Mosca, *Magnetic forces doing work?*, *Am. J. Phys.* 42 (1974) 295.
5. J. A. Redinz, *Forces and work on a wire in a magnetic field*, *Am. J. Phys.* 79 (2011) 774.